

AUTOMATIC 4_VIEW 2D VECTOR
FROM RHINO MODEL

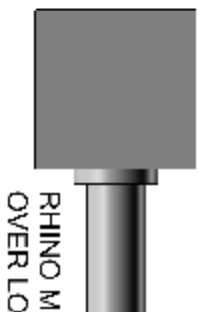

RHINO MODEL MADE
OVER LOCKED SU MESH

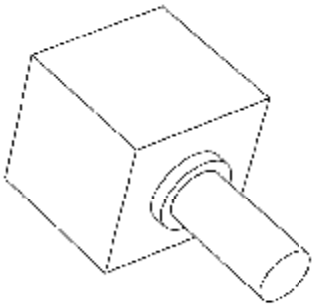
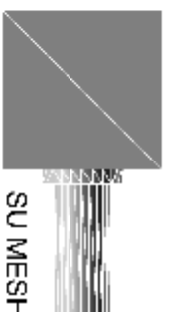
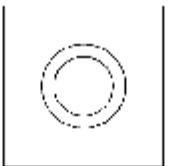
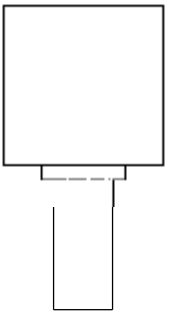

SU MESH

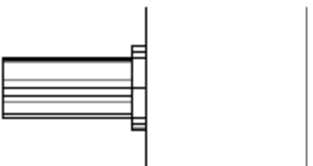
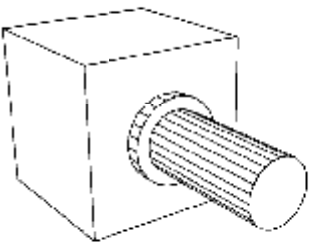

RHINO MODEL AUTOMATICALLY
MADE FROM SU MESH ON IMPORT

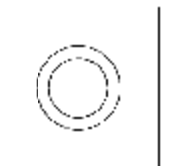
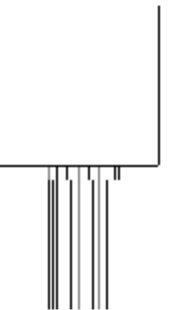

AUTOMATIC 4_VIEW 2D VECTOR
FROM AUTOMATICALLY CONVERTED
SU MESH