

3skeng References - Users and their applications (Extract)

Teaming up SketchUp and 3skeng can be a powerful combination to approach many applications – as long as they include either Pipe, circular & rectangular duct, secondary steelwork (like C-Channel) and/or primary steelwork (like T-section beams).

Actual applications range from conceptual to detail, from small to big, from trivial to pompous and from obvious (e.g. facility engineering) to less obvious (e.g. aquarium building).

In the following, we present a few examples:

Conceptual Design - Facility Engineering

3D conceptual design and space management for a Semiconductor manufacturing factory with a cleanroom of 46.500 m² / 500,000 ft².

Design for the most critical, space-demanding utilities exhaust and make-up-air.

Used software: SketchUp Pro, 3skeng Tools Pipe (conceptual), Channel & Steelwork

Designed by SHK Engineering and Consulting, Germany - www.shk.com

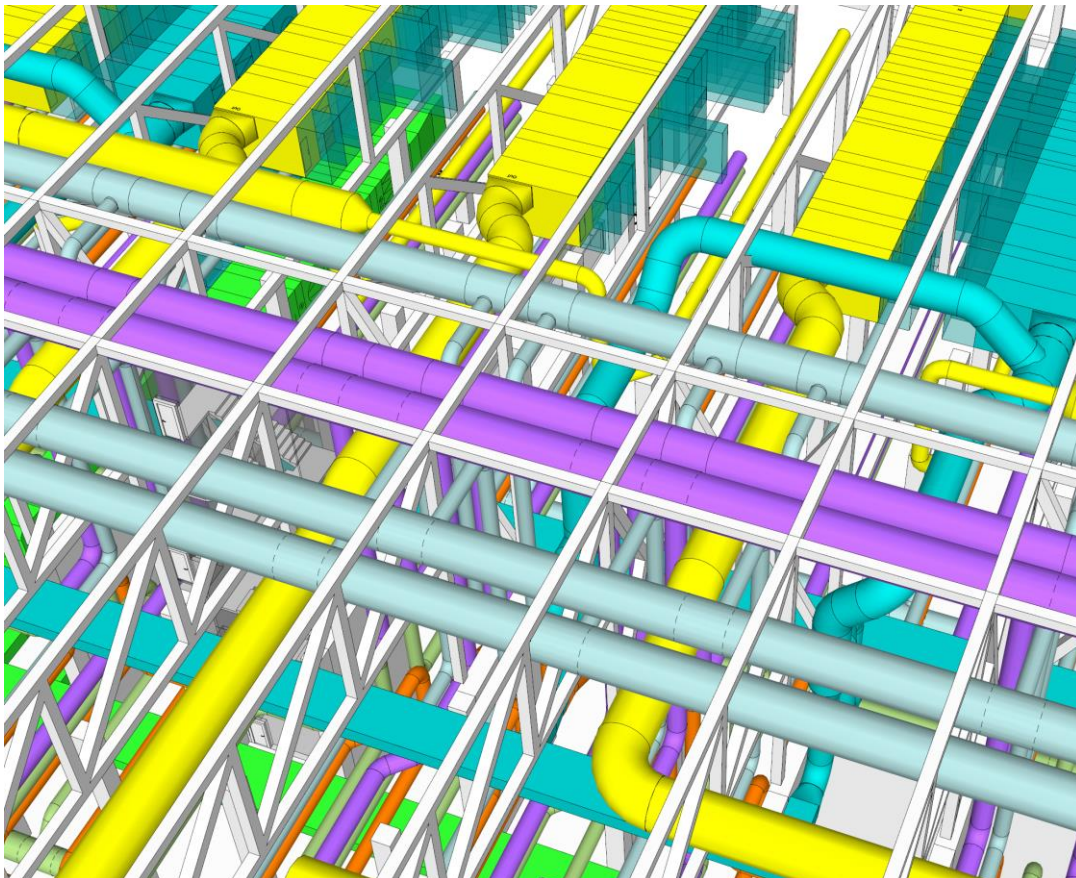

3D view of exhaust and make-up-air design

Detail design - Facility Engineering

3D detail design and space management for a large Semiconductor manufacturing factory with a cleanroom of 14,000 m² / 150,000 ft² and 78 km / 48 mi of pipe, duct and cable tray. Used software: SketchUp Pro, 3skeng Tools Pipe (detail), Mount, Channel & Steelwork
Designed by SHK Engineering and Consulting, Germany - www.shk.com

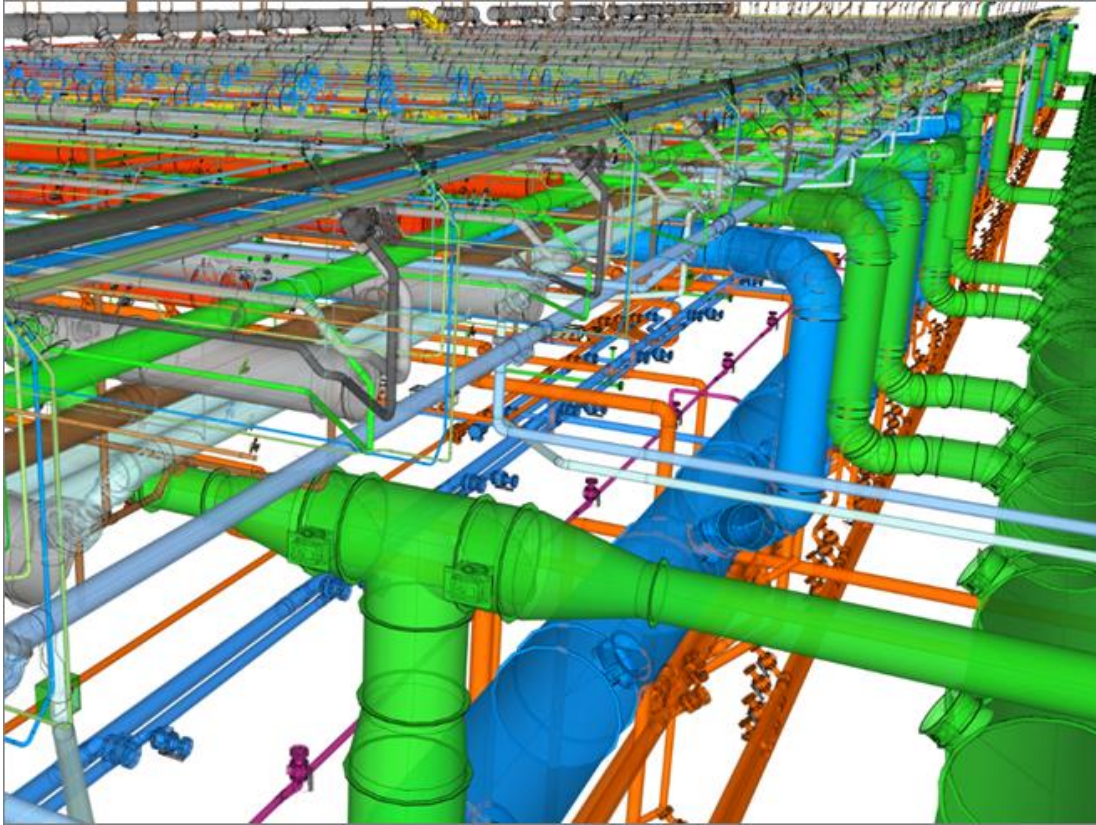

3D section view of main supply lines

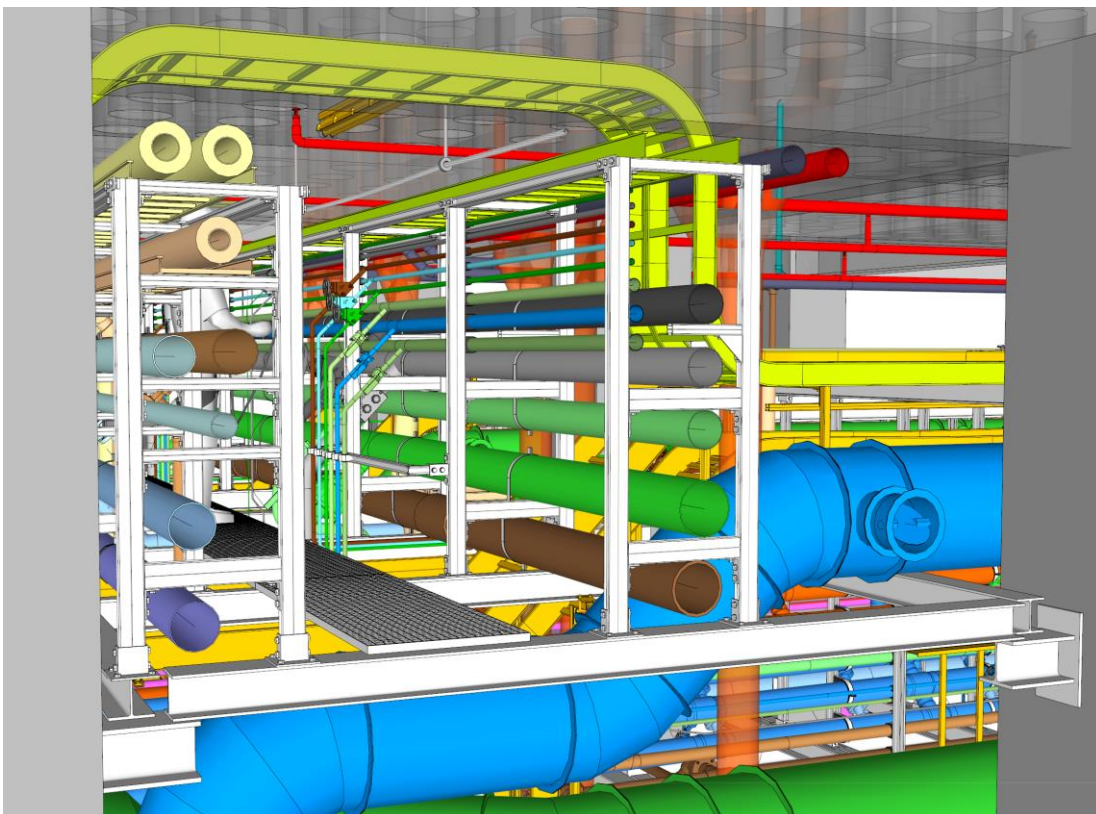

3D section view of main supply lines

Detail design - Facility Engineering

3D detail design and space management for a Semiconductor manufacturing factory and generation of tender documents.

Used software: SketchUp Pro, 3skeng Tools Pipe (detail), Channel & Steelwork

Designed by SHK Engineering and Consulting, Germany - www.shk.com

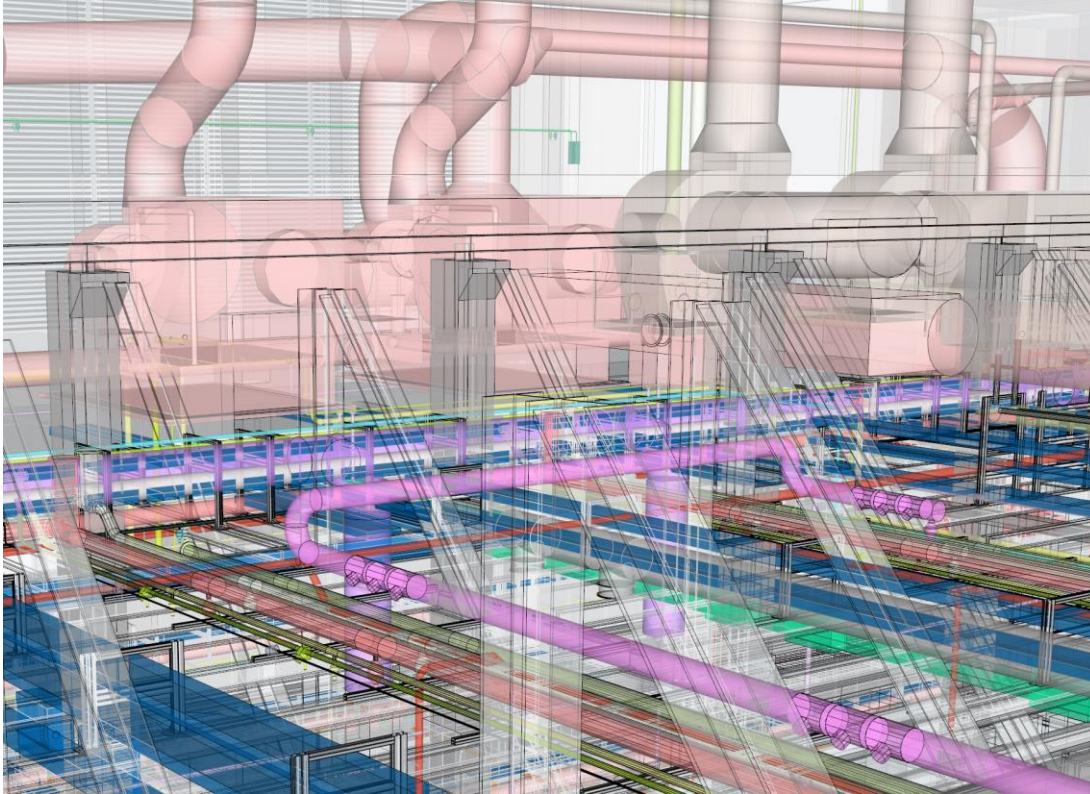

3D view of infrastructure

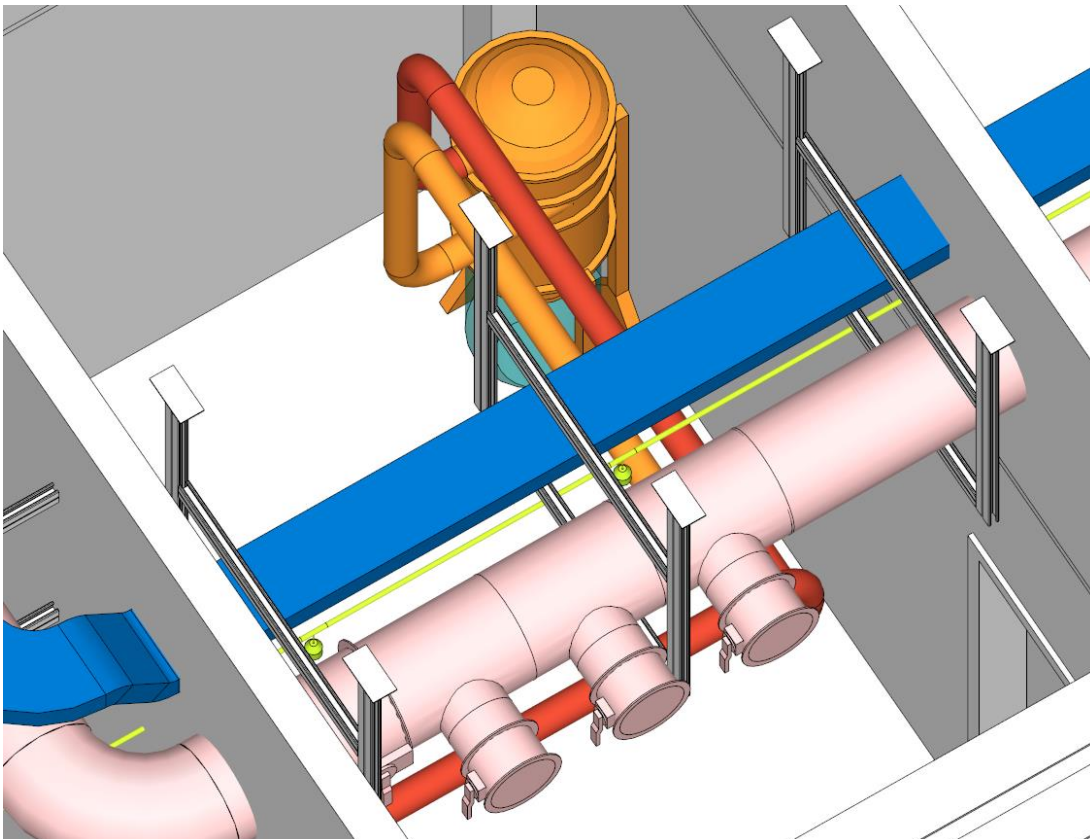

3D view of central vacuum generation

Detail design - Facility Engineering

3D detail design and space management for a laboratory building and generation of tender documents.

Used software: SketchUp Pro, 3skeng Tools Pipe (detail), Channel & Steelwork

Designed by SHK Engineering and Consulting, Germany - www.shk.com

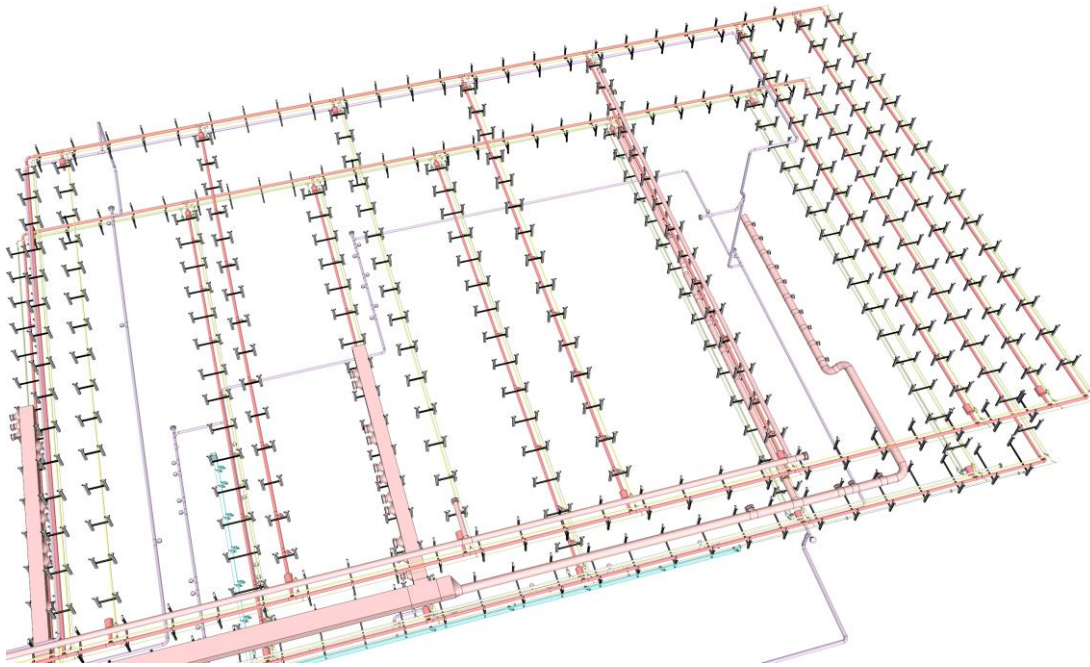

3D view of infrastructure

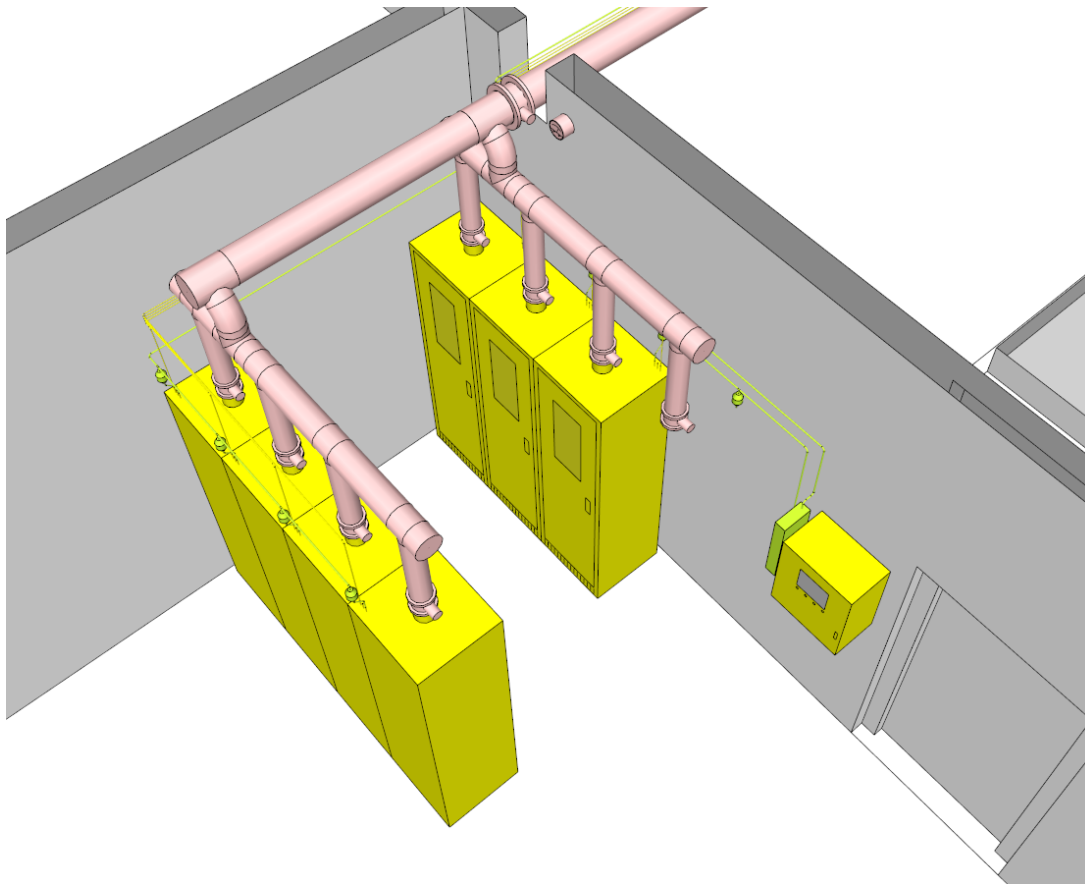

3D view of special gas room

Detail design - Hook-Up Engineering

3D detail design of hook-up connections for all required utilities and generation of tender documents.

Used software: SketchUp Pro, 3skeng Tools Pipe (detail), Channel & Steelwork

Designed by SHK Engineering and Consulting, Germany - www.shk.com

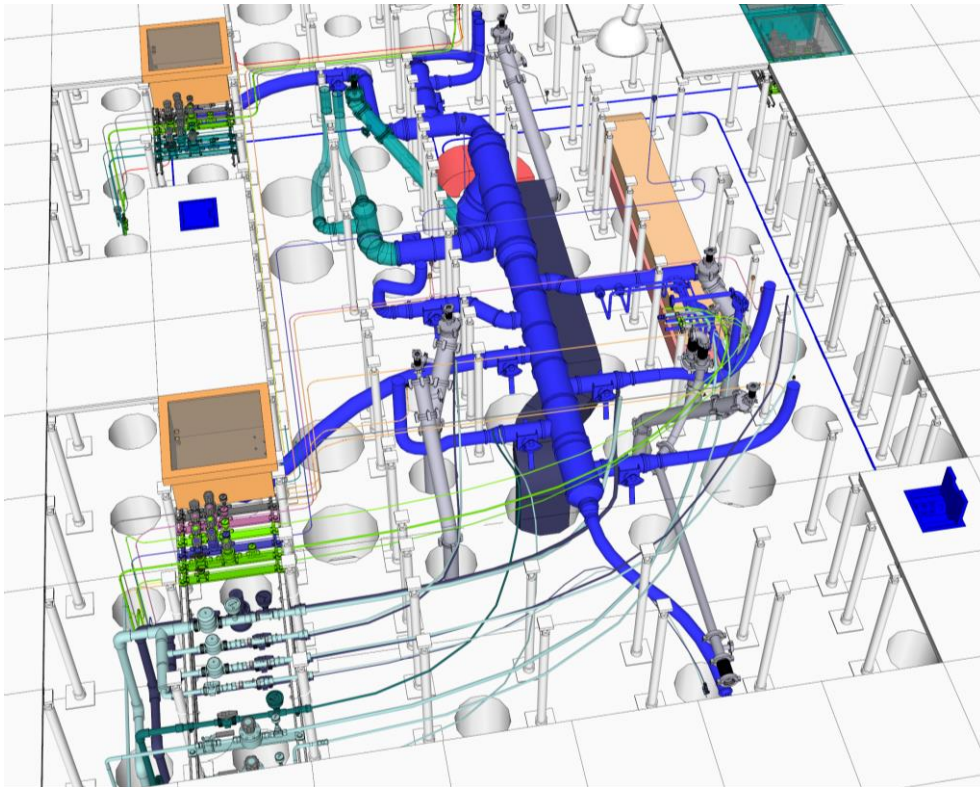

3D view of installations in raised metal floor

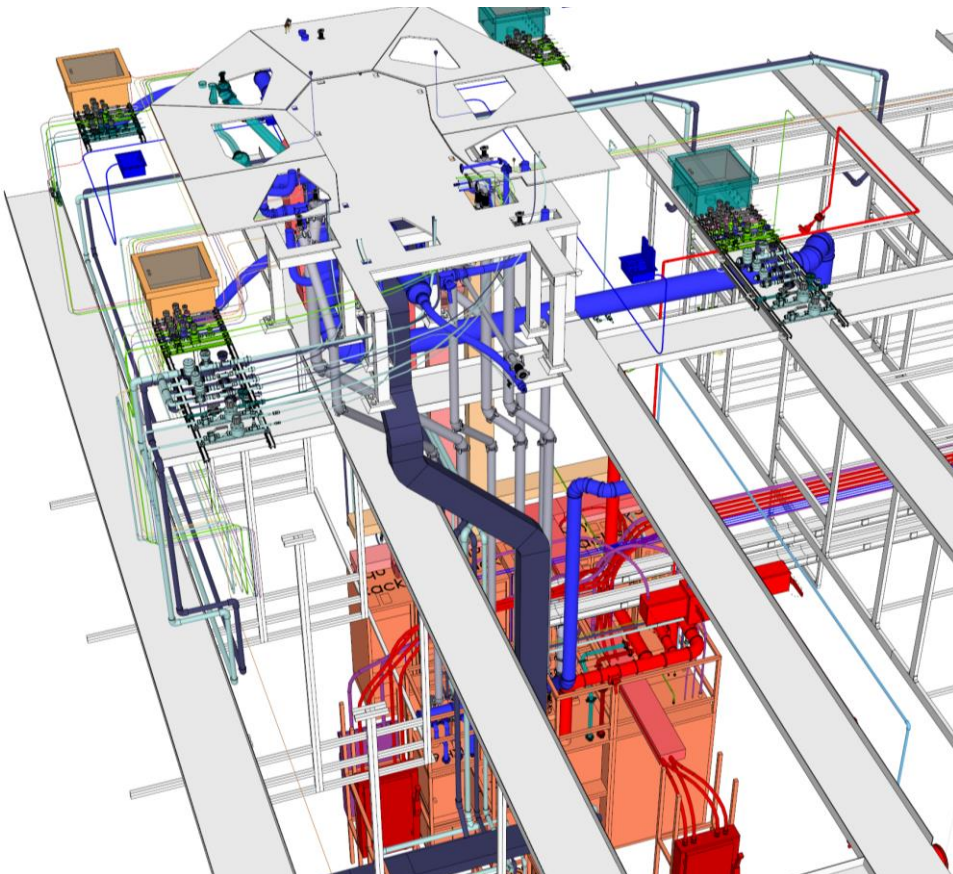

3D view of installations between fab and subfab level