

18/05/2015

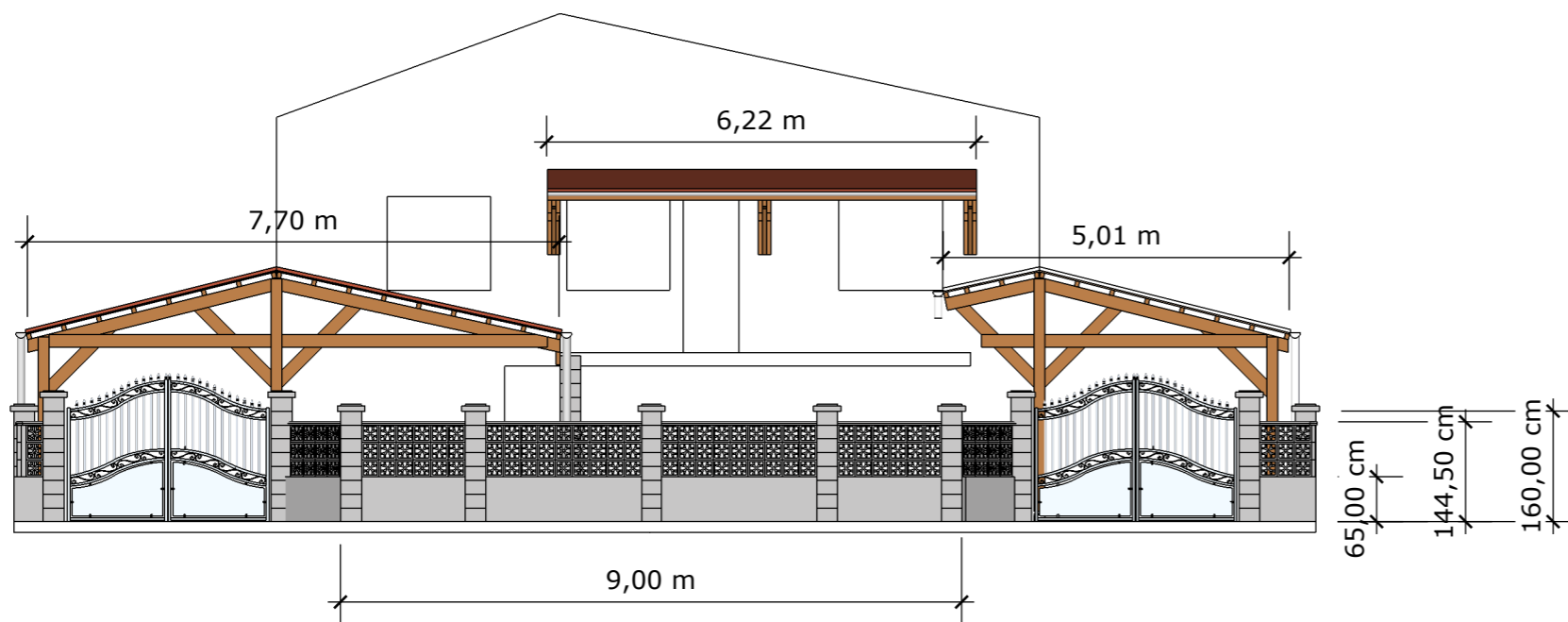

18/05/2015

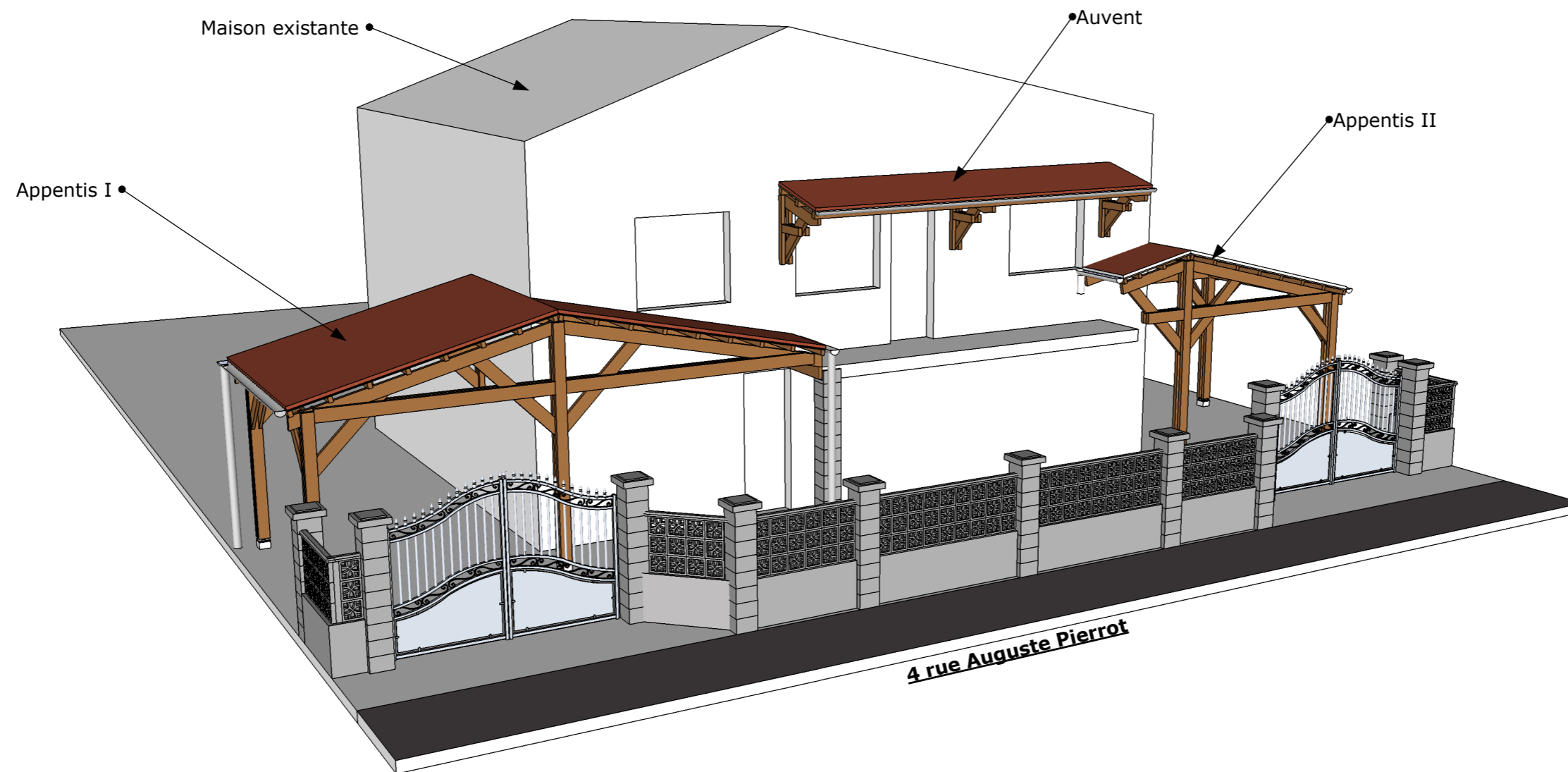
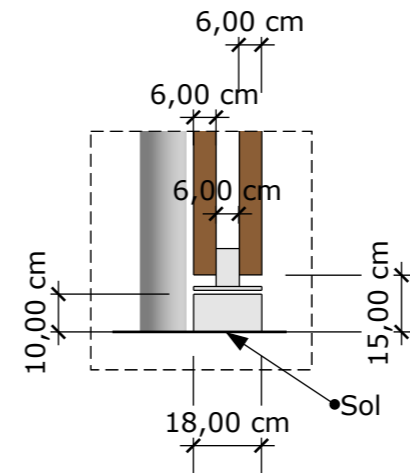
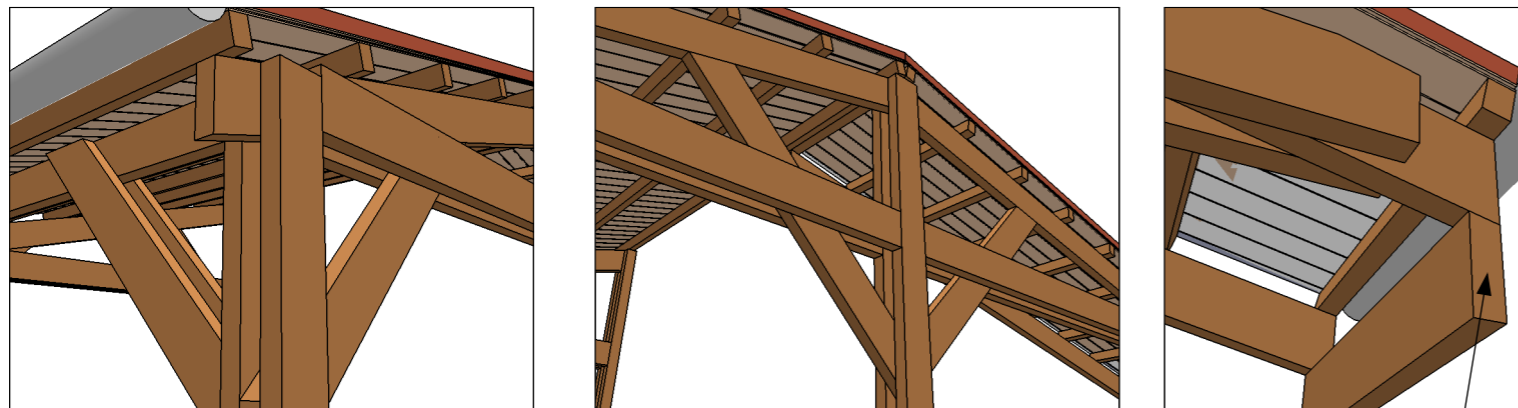
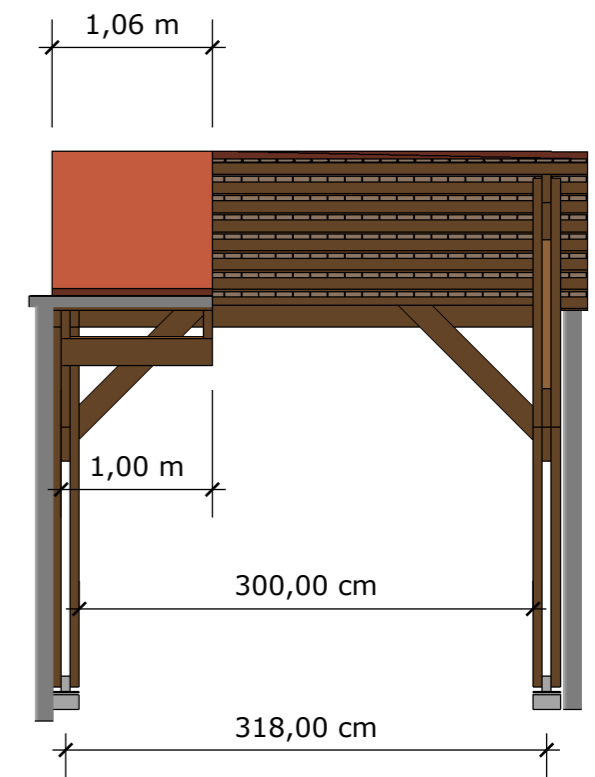
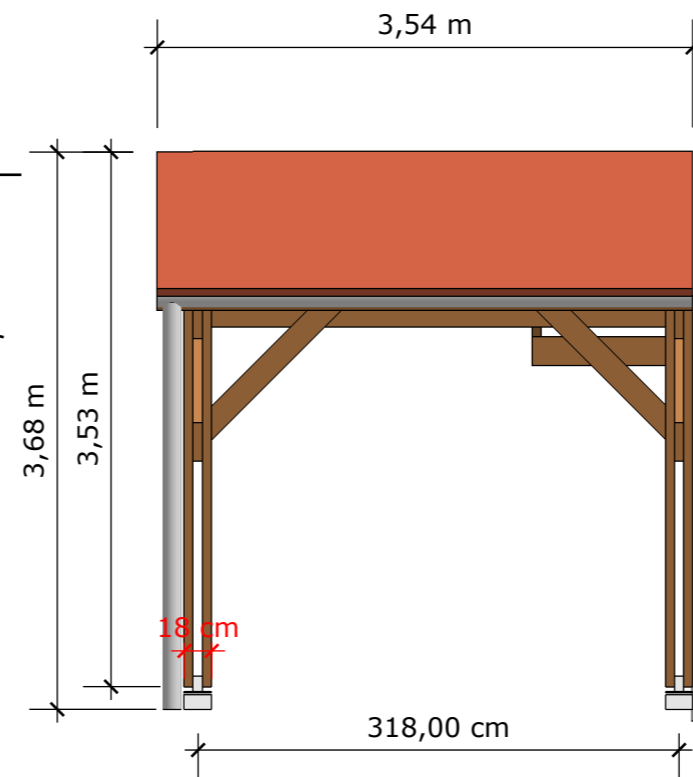
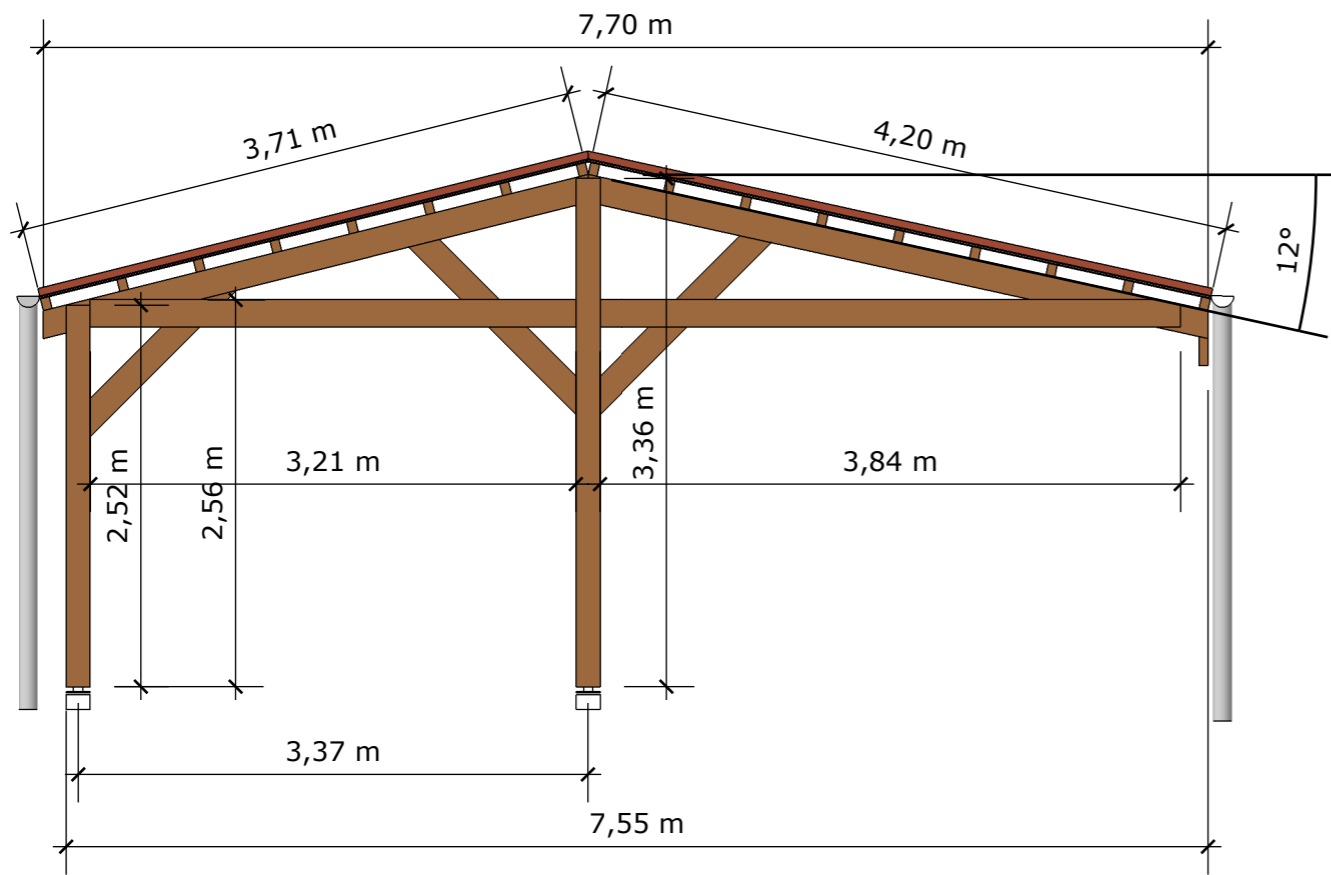

Les sections des éléments de charpente sont données à titre indicatif, néanmoins elles ont déjà fait l'objet d'un précalcul de stabilité selon la NV66, par le client, ingénieur structure.

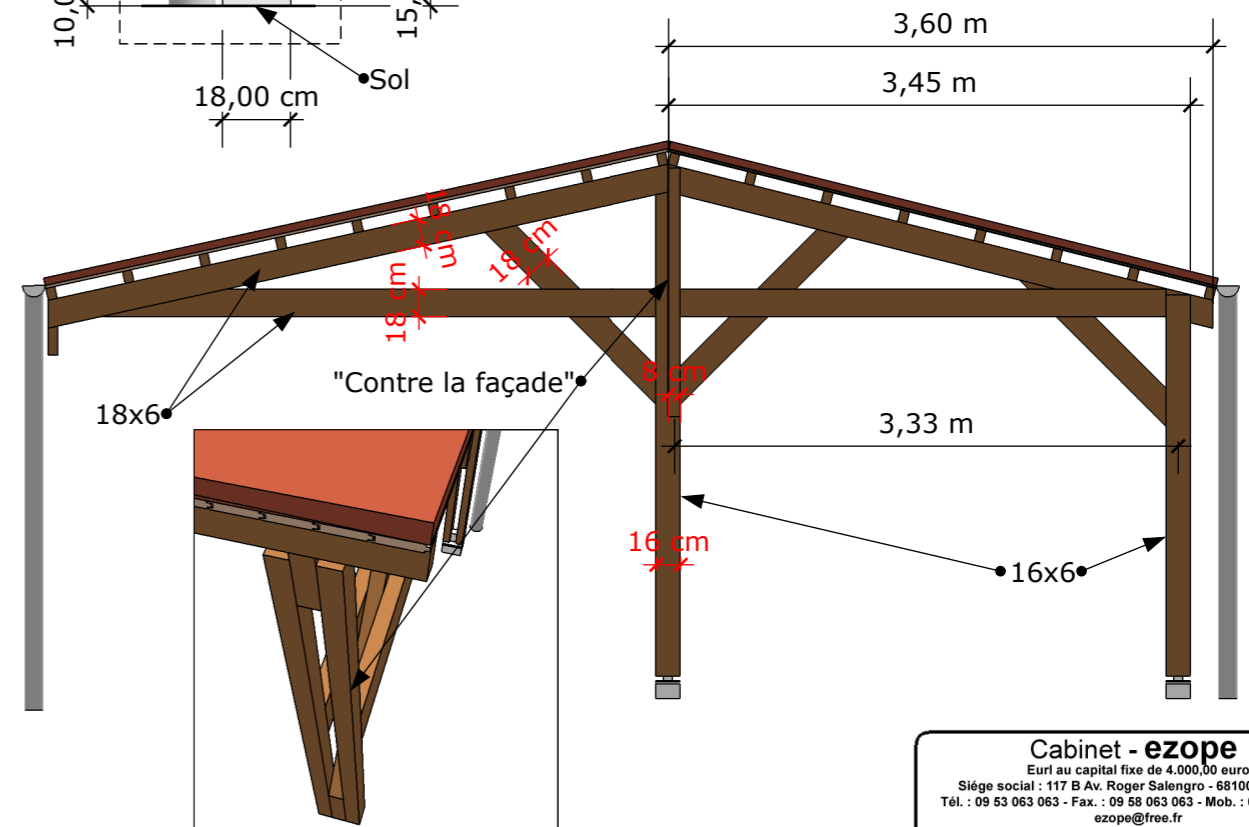
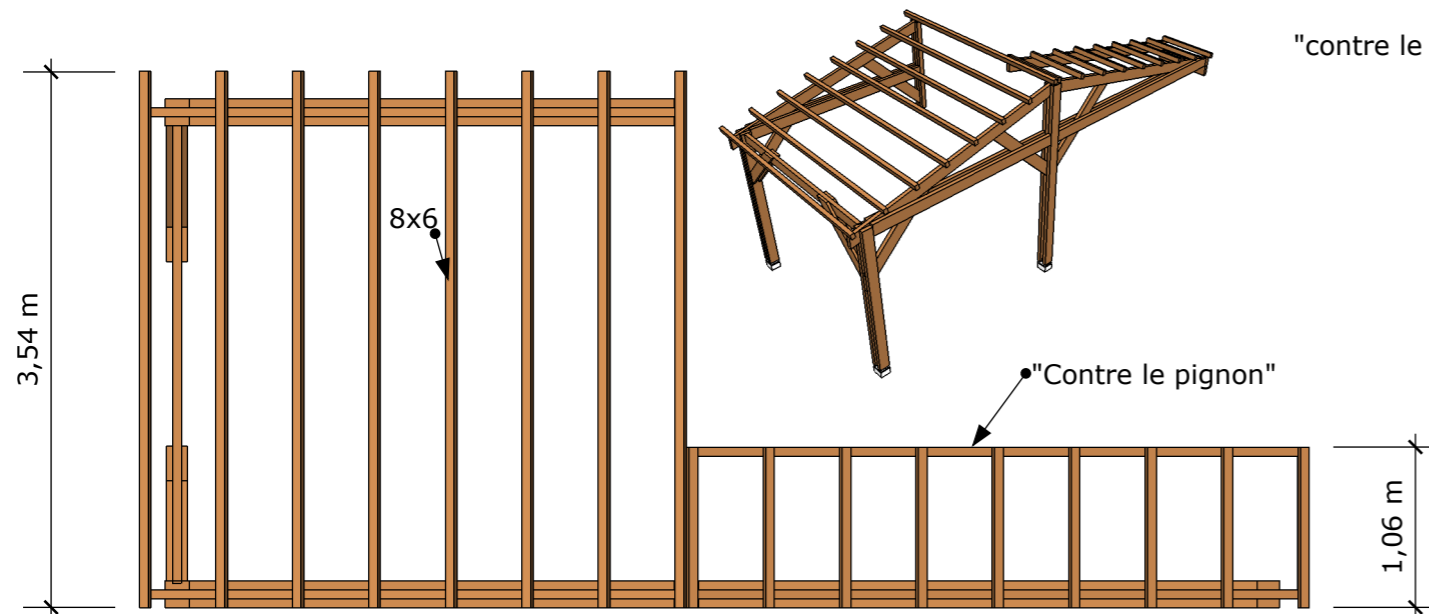

18/05/2015

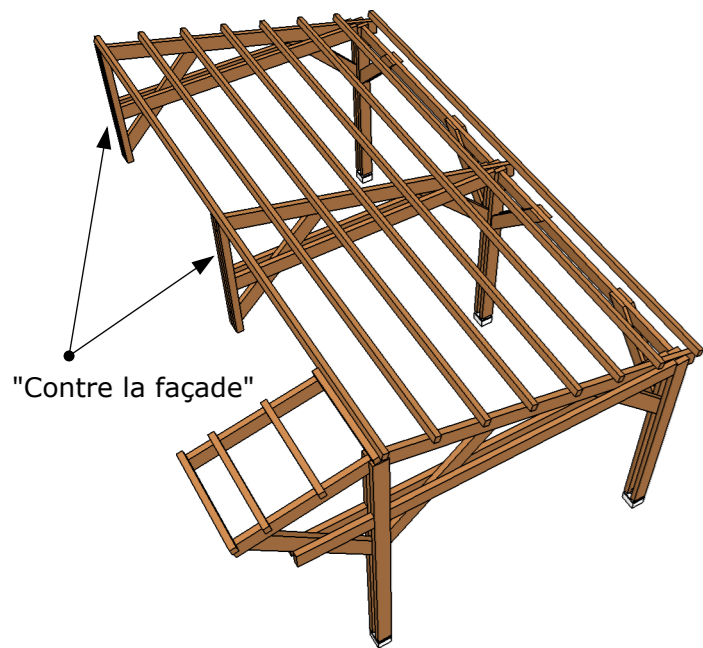
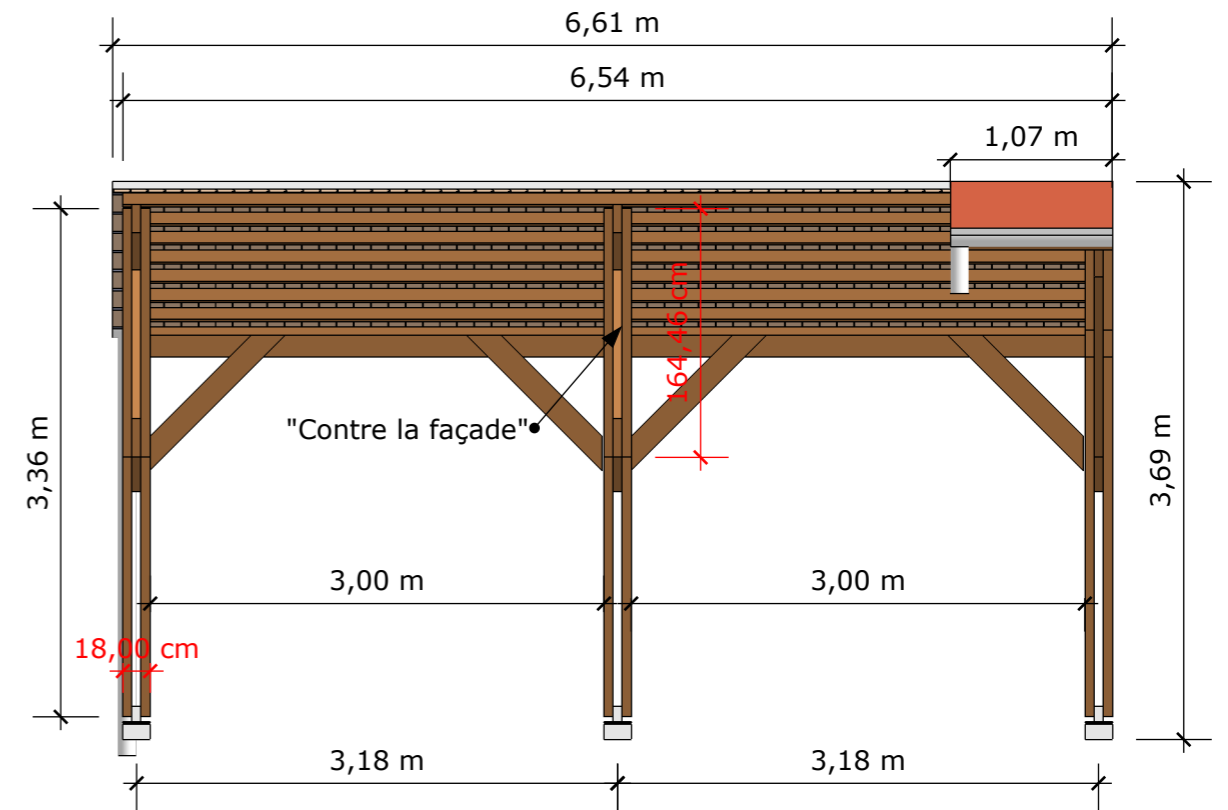
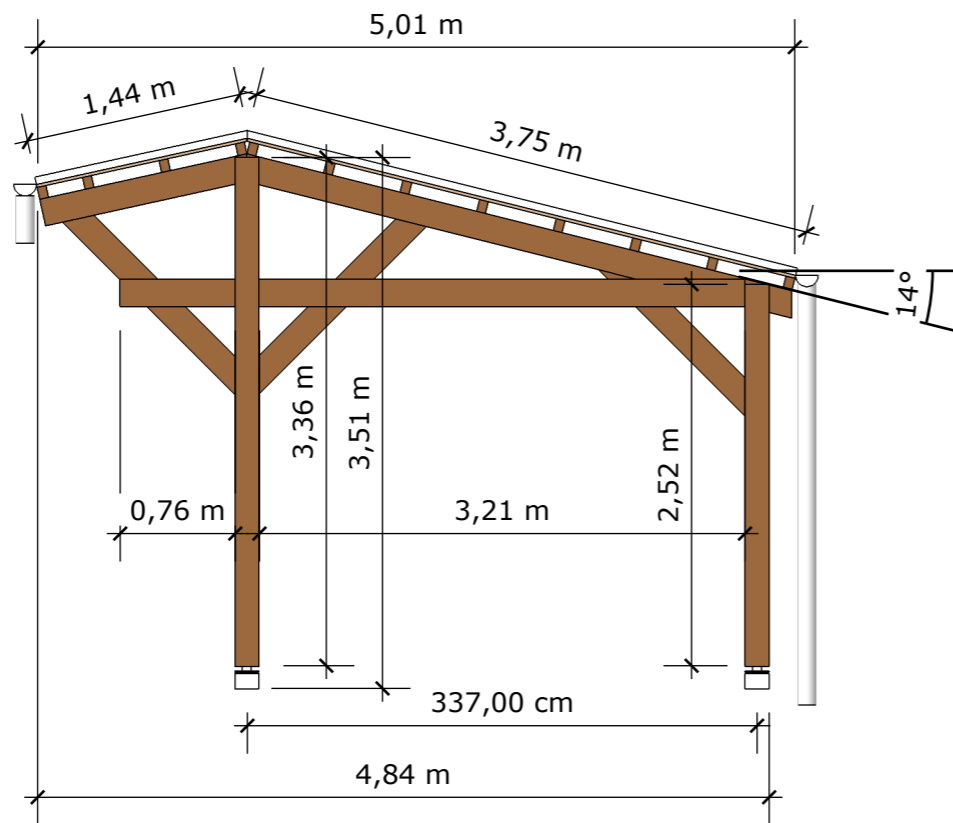

"Contre le pignon"

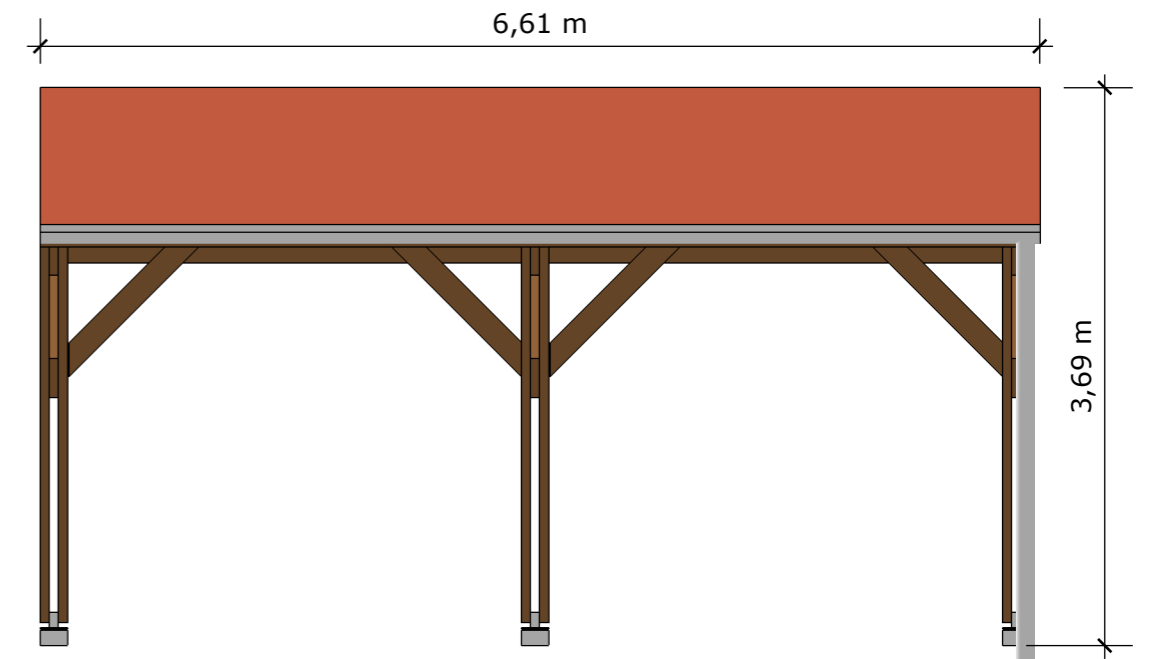
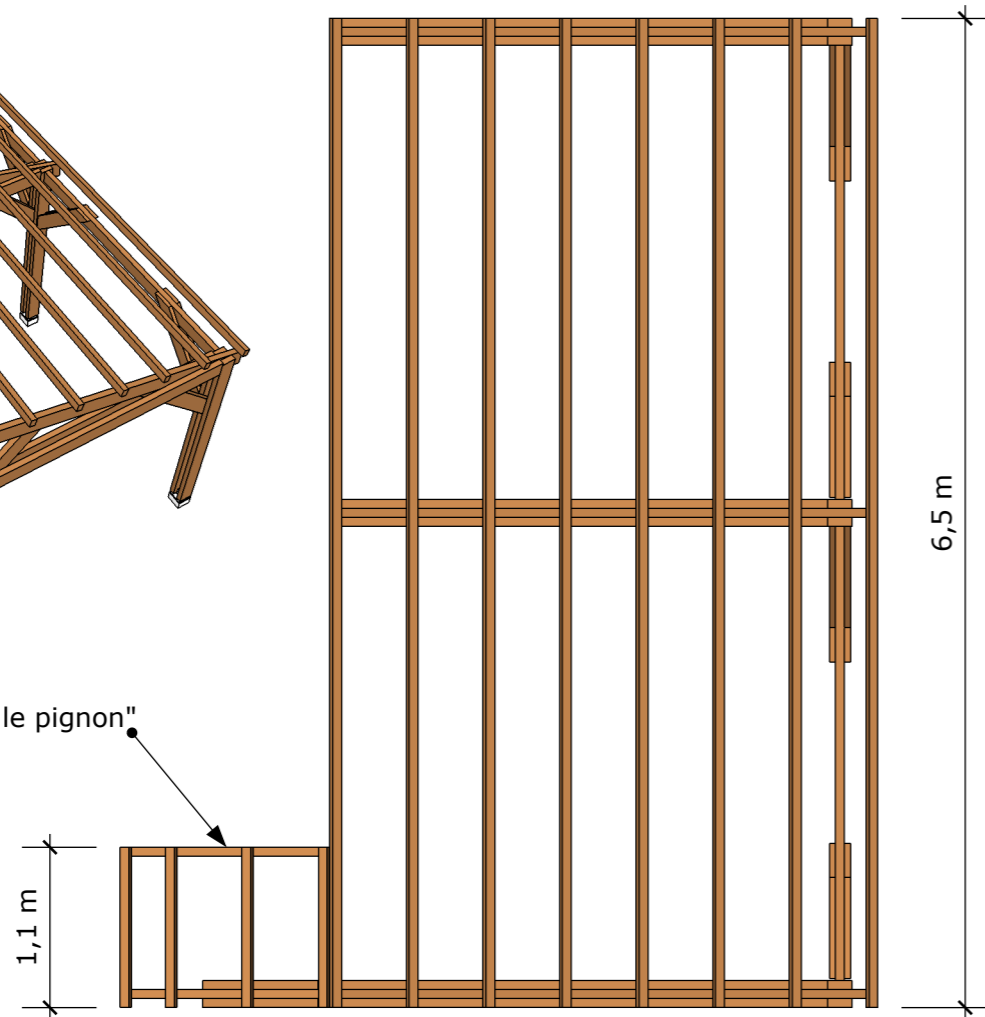

Détails et sections dito l'appentis I

